

USB1 Audio/USB2 Audio

▼ USB1 Audio/USB2 Audio

Audio can be played by connecting a commercially-available memory or music player to the vehicle's USB port.

Connecting devices

Connect the USB audio device to the vehicle using the USB cable. Insert or pull out the plug with the plug perpendicular to the USB port hole.

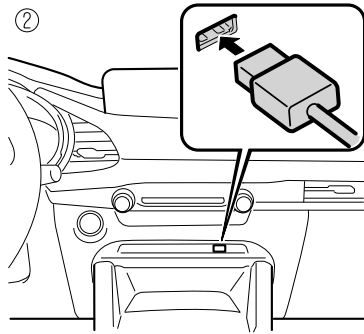
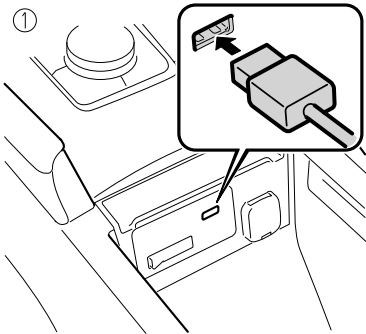

1. Located on center console
2. Located on dashboard

The location of the USB port differs depending on the vehicle model.

Playing music

1. Select “Entertainment” on the home screen.

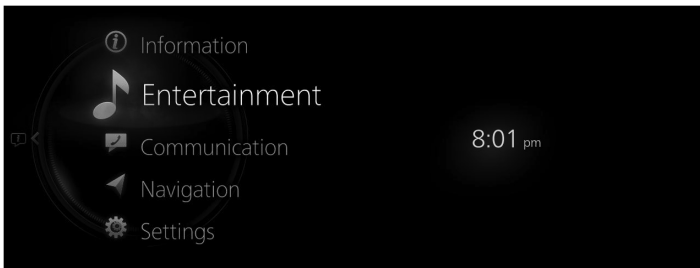

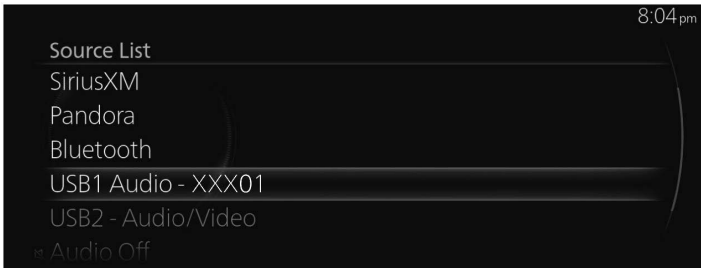

2. Select “USB1 Audio - [device name]” or “USB2 Audio - [device name]”.

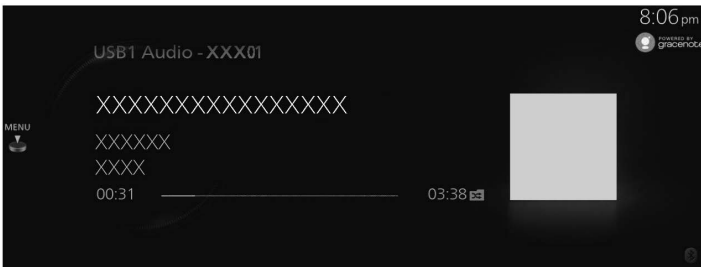

3. The playback screen is displayed.



Rotate the  to display the Track List.

When the  is displayed, you can display the menu by pressing the .

USB audio menu

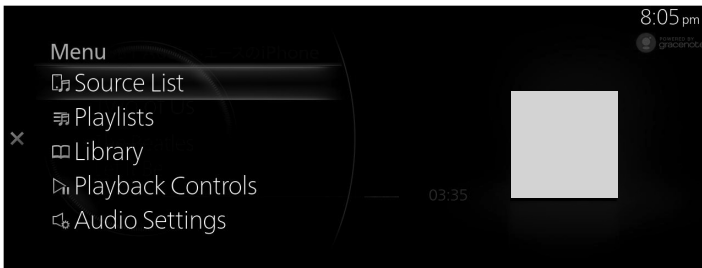

Menu	Explanation
Source List	Displays the Source List screen. You can switch the audio source.
Folders*1	Displays the folder list. You can select the music you want to listen to from the folder.
Playlists*2	Displays the playlist. You can select the music you want to listen to from the playlist.
Library	Displays the Library screen. You can select the category you want to play such as album or artist. For details, refer to Selecting tracks from the Library.
Playback Controls	Displays the control screen (icon) on the playback screen. For the operation method for each icon, refer to How to Use the Control Screen (icon).
Audio Settings	Adjusts the sound quality.

*1 Displayed when connected to a device other than an Apple device.

*2 Displayed when connected to an Apple device.

Selecting tracks from the Library

1. Select the category from the Library screen.



2. Select the playback method for the song from the category list.

Category	Explanation
Playlists*1	Displays the list of playlists and plays the selected playlist as a track list.
Artists	Displays the list of artists and plays the selected artist's album or all the tracks as a track list.
Albums	Displays the list of artists and plays the selected artist's album or all the tracks as a track list.
Songs	Displays the list of all the tracks and plays all the tracks as a track list. In addition, you can search for the track you want to listen to using an alphabetical search.
Genres	Displays the list of the music genres and plays artist-separate or album-separate tracks in the selected genre, or all the tracks as a track list.

Category	Explanation
Composers	A list of composers is displayed where you can select the album for a composer or all of the tracks and play them as a track list.
Podcasts*2	Displays the Podcast list and plays the selected episode.
Audiobooks*2	Displays the audio book list and plays the selected chapter.

*1 Displayed when connected to a device other than an Apple device.

*2 Displayed when connected to an Apple device.

Example of use (when playing tracks of a selected artist)

1. Select “Artists”.

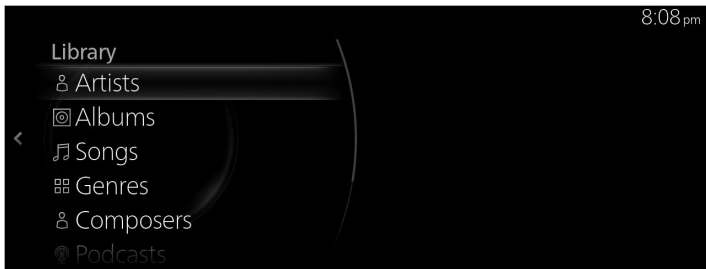

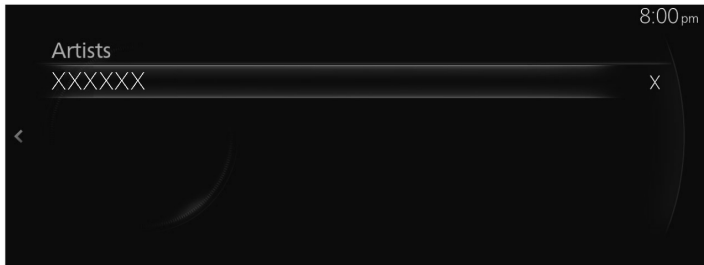

2. Select the artist you want to listen to.





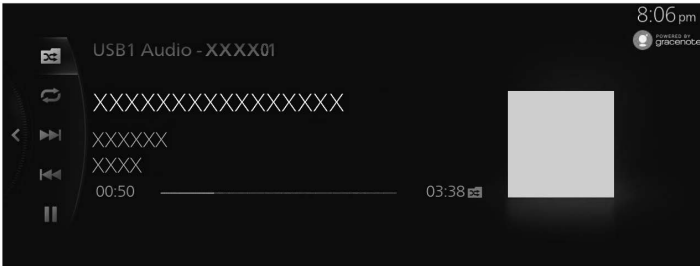









3. Select the track name you want to listen to from the list of displayed track names. The selected track is played.

How to Use the Control Screen (icon)



Rotate the  to select the icon you want to operate.

Icon	Explanation
	When USB devices other than Apple products, such as USB memory and audio players are connected
	 Plays the tracks in the folder currently selected in random order.
	 Plays all the tracks randomly.
	 Cancels random playback.
	When an Apple product is connected
	 Shuffles the playback of all of the tracks in the currently selected playlist or album.
	 Repeats the playback of the song being played.
	 Repeats the playback of all of the tracks in the currently selected folder, playlist, or album.
	 Cancels the repeat playback.
	Advances to the beginning of the next song. Press and hold to fast forward. Release it to stop.
	Returns to the beginning of the previous song. Press and hold to fast reverse. Release it to stop.
	(When selected during pause) Plays the track.

Icon	Explanation
	(When selected during playback) Pauses the track.

Album art displayed during USB audio playback

When connecting a USB audio device to this unit and playing audio, the unit searches the database stored in the vehicle for the album art. If there is a match in the vehicle's database compilation to the music being played, the album art is displayed. The database information stored in this device uses database information in the Gracenote® music recognitions service.

Album art display priority

You can change the album art display priority to either the album art saved in the USB audio device or the Gracenote® database.

Updating the database

The Gracenote® database can be updated using a USB Audio device. Select “Gracenote Database Update” from the System Settings screen.